

STANDARD INJECTION MOULDS

FOR INJECTION MACHINE IMK1 & IMK2

Our high quality aluminum standard moulds offer an incredible workflow and create access to a large variety of different three dimensional shaped objects. Attached you find our standard moulds for our injection machine which we mostly have in stock.

- Very fast workflow
- Almost unlimited range of designs
- Awesome price-performance ratio
- Complex shapes are possible
- High quality finish of the final product
- Very durable (3000+ shots with one mould)

3D Aluminum Standard Mould Order	Custom Mould Order
To place an order for our 3D aluminum standard moulds, please contact us at the following email address: products@plasticpreneur.com	If you desire the creation of custom moulds tailored more closely to your needs, please send us an email to: moulds@plasticpreneur.com

WORKFLOW

The "workflow" indicates how fast the handling of a form is in the work process. This includes the time for opening and closing the injection mould as well as demoulding the injected part.

- ● ● ● ● **very slow** – not efficient for serial production
- ● ● ● ● **slow** – depends on the product if it is cost efficient for serial production
- ● ● ● ● **medium** – ok for serial production
- ● ● ● ● **fast** – good for serial production
- ● ● ● ● **super fast** – excellent for serial production

For Workshops we recommend using moulds with a workflow of at least ● ● ● ● ● (3) or even ● ● ● ● ● (4) workflow points.

ABBREVIATIONS GLOSSARY

L = Length	W = Width
H = Height	D = Diameter

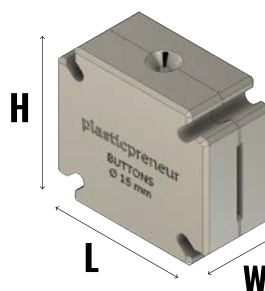

Ashtray Mould

Ashtray for collecting cigarettes.

Plastic per mould:	34 g
Products per mould:	1
Plastic per product:	33 g
Workflow:	●●●●●
Size product:	D: 80 mm H: 25 mm
Size mould:	H: 45 mm D: 120 mm
Weight mould:	1.3 kg
Price:	475 €*



Bowl Mould

Perfect as a decorative non food bowl for accessories or gadgets.



Plastic per mould:	76 g
Products per mould:	1
Plastic per product:	75 g
Workflow:	●●●●●
Size product:	D1: 175 mm D2: 90 mm H: 35 mm
Size mould:	H: 65 mm D: 210 mm
Weight mould:	6 kg
Price:	450 €*

Beads Mould 12 x 8.8 mm 10 pcs

Perfect as a necklace or as pearls for an abacus.

Plastic per mould:	10.3 g
Products per mould:	10
Plastic per product:	0.6 g
Workflow:	●●●●●
Size product:	D1: 12 mm D2: 2.6 H: 8.8 mm
Size mould:	H: 80 mm L: 90 mm W: 40 mm
Weight mould:	0.7 kg
Price:	300 €*

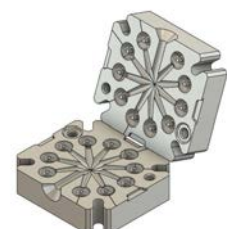

Buttons Mould Ø 11 mm

Suitable size for most shirts.

Plastic per mould:	5 g
Products per mould:	10
Plastic per product:	0.2 g
Workflow:	●●●●●●
Size product:	D: 11.3 mm H: 2.4 mm
Size mould:	H: 75 mm L: 80 mm W: 40 mm
Weight mould:	0.6 kg
Price:	350 €*

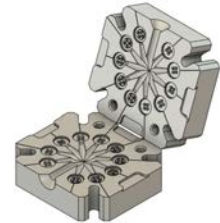
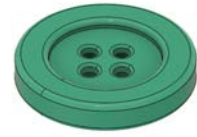

Buttons Mould Ø 15 mm

Suitable size for most shirts.

Plastic per mould:	7.4 g
Products per mould:	10
Plastic per product:	0.4 g
Workflow:	●●●●●●
Size product:	D: 15.25 mm H: 2.75 mm
Size mould:	H: 80 mm L: 90 mm W: 40 mm
Weight mould:	0.7 kg
Price:	400 €*

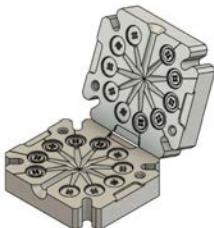

Buttons Mould Ø 20 mm

Suitable size for most shirts.

Plastic per mould:	15 g
Products per mould:	10
Plastic per product:	1 g
Workflow:	●●●●●●
Size product:	D: 20.3 mm H: 4 mm
Size mould:	H: 110 mm L: 120 mm W: 50 mm
Weight mould:	1.6 kg
Price:	450 €*

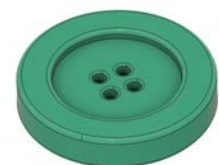

Button Mould Ø 28 mm

Suitable size for most jackets.

Plastic per mould: 25 g
 Products per mould: 8
 Plastic per product: 2.45 g
 Workflow: ●●●●●●●●

Size product: D: 28.5 mm H: 5 mm
 Size mould: H: 115 mm L: 135 mm W: 50 mm
 Weight mould: 1.9 kg

Price: 500 €*



Carabiners Mould

Perfect as a giveaway for workshops or to fix light items such as keys or bottles – not strong enough to go climbing with.

Plastic per mould: 32 g
 Products per mould: 4
 Plastic per product: 7.3 g
 Workflow: ●●●●●●●●

Size product: L: 68.5 mm W: 42.5 mm H: 9 mm
 Size mould: H: 120 mm L: 150 mm W: 40 mm
 Weight mould: 1.7 kg

Price: 450 €*

Checkers Game Figures Mould

Used for checkers as well as other board games.

Plastic per mould: 15 g
 Products per mould: 5
 Plastic per product: 2.6 g
 Workflow: ●●●●●●●●

Size product: D: 26 mm H: 6.5 mm
 Size mould: H: 85 mm L: 90 mm W: 40 mm
 Weight mould: 0.7 kg

Price: 350 €*

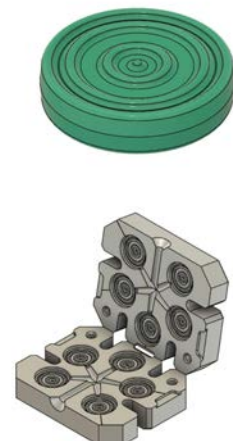

Clothing Hooks Mould small

Perfect for hanging up hoodies.

Plastic per mould: 19 g
 Products per mould: 2
 Plastic per product: 7.5 g
 Workflow: ●●●●●●

Size product: L: 100.9 mm W: 30 mm H: 12 mm
 Size mould: H: 115 mm L: 100 mm W: 40 mm
 Weight mould: 1.1 kg

Price: 450 €*



Clothing Hooks Mould large

Perfect for hanging up jackets.

Plastic per mould: 45 g
 Products per mould: 2
 Plastic per product: 21 g
 Workflow: ●●●●●●

Size product: L: 155.9 mm W: 45 mm H: 20 mm
 Size mould: H1: 165 mm H2: 130 mm
 L: 130 mm W: 50 mm
 Weight mould: 2.3 kg

Price: 500 €*



Clothing Pegs Mould

Long lasting peg to hang up your clothes without any need of metal springs.

Plastic per mould: 24 g
 Products per mould: 2
 Plastic per product: 11 g
 Workflow: ●●●●●●

Size product: L: 65 mm W: 60 mm H: 8 mm
 Size mould: H: 70 mm L: 160 mm W: 40 mm
 Weight mould: 1.1 kg

Price: 350 €*

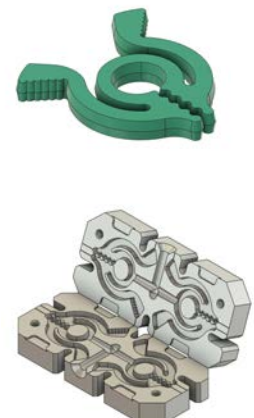

Combs Mould

Perfect for most long hair – lovely as a gift. Ideal for engraving.

Plastic per mould: 41.6 g
 Products per mould: 2
 Plastic per product: 20.3 g
 Workflow: ●●●●●●

Size product: L: 142 mm W: 55 mm H: 4.5 mm
 Size mould: H: 160 mm L: 160 mm W: 50 mm
 Weight mould: 3.2 kg

Price: 500 €*

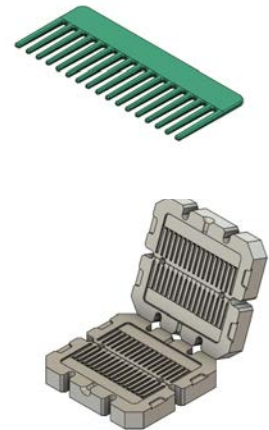

Door Knobs Mould Ø 30 mm

Perfect knob for drawers or to hang up jackets.

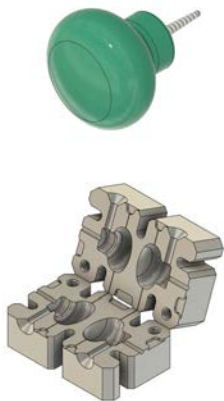

Plastic per mould: 22 g
 Products per mould: 2
 Plastic per product: 10 g
 Workflow: ●●●●●●

Size product: D1: 30 mm D2: 15 mm H1: 27 mm
 Size mould: H: 50 mm L: 90 mm W: 5 mm
 Weight mould: 0.5 kg

Price: 300 €*

Door Knobs Mould Ø 50 mm

Perfect knob for doors or to hang up jackets.

Plastic per mould: 91 g
 Products per mould: 2
 Plastic per product: 44 g
 Workflow: ●●●●●●

Size product: D1: 50 mm D2: 22.5 mm H: 45 mm
 Size mould: H: 80 mm L: 135 mm W: 60 mm
 Weight mould: 1.6 kg

Price: 350 €*



Flower Pot Mould small

Perfect for small plants like cactus or flowers.

Plastic per mould: 40 g
 Products per mould: 1
 Plastic per product: 39 g
 Workflow: ●●●●○

Size product: D1: 70 mm D2: 50 mm H: 70 mm
 Size mould: H: 95 mm D: 95 mm
 Weight mould: 1.75 kg

Price: 350 €*

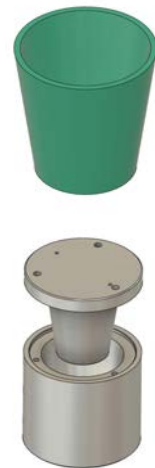

Flower Pot Saucer Mould small

Perfect saucer for our Flower Pot small.



Plastic per mould: 32 g
 Products per mould: 1
 Plastic per product: 30 g
 Workflow: ●●●●○

Size product: D1: 85.5 mm D2: 80 mm H: 20.5 mm
 Size mould: H: 45 mm D: 120 mm
 Weight mould: 1.3 kg

Price: 425 €*

Flower Pot Mould medium

Perfect for most medium size plants.

Plastic per mould: 72 g
 Products per mould: 1
 Plastic per product: 70 g
 Workflow: ●●●●○

Size product: D1: 100 mm D2: 70 mm H: 85 mm
 Size mould: H: 110 mm D: 130 mm
 Weight mould: 3.8 kg

Price: 400 €*



Flower Pot Saucer Mould medium

Perfect saucer for our Flower Pot medium.

Plastic per mould: 54 g
 Products per mould: 1
 Plastic per product: 52 g
 Workflow: ●●●●○

Size product: D1: 113.5 mm D2: 106 mm H: 25.5 mm
 Size mould: H: 50 mm D: 150 mm
 Weight mould: 2,2 kg

Price: 475 €*

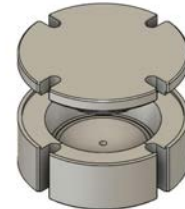

Flower Pot Mould large

Perfect for most large household plants.

Plastic per mould: 112 g
 Products per mould: 1
 Plastic per product: 110 g
 Workflow: ●●●●○

Size product: D1: 110 mm D2: 80 mm H: 105 mm
 Size mould: H: 135 mm D: 145 mm
 Weight mould: 5.9 kg

Price: 550 €*

Flower Pot Saucer Mould large

Perfect saucer for our Flower Pot large.

Plastic per mould: 68 g
 Products per mould: 1
 Plastic per product: 64 g
 Workflow: ●●●●○

Size product: D1: 120 mm D2: 112 mm
 H: 30 mm WT: 3 mm
 Size mould: H: 50 mm D: 160 mm
 Weight mould: 2.5 kg

Price: 550 €*

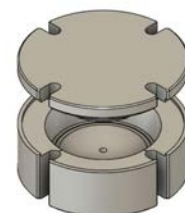

Hexagon Coaster Mould blank

Hexagon Tile with two flat sides – perfect as a coaster or tile. Ideal for engraving.

Plastic per mould: 26 g
 Products per mould: 1
 Plastic per product: 25 g
 Workflow: ●●●●●○

Size product: L: 90 mm W: 103 mm H: 4 mm
 Size mould: H: 115 mm L: 120 mm W: 50 mm
 Weight mould: 1.7 kg

Price: 250 €*

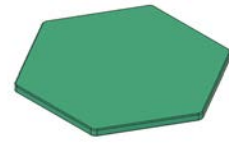

Hexagon Coaster / Tile Mould structured

One side has a structure – perfect to cover your wall – just glue the structured side onto the wall.

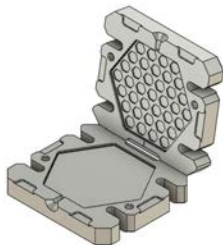
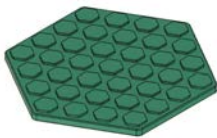

Plastic per mould: 30 g
 Products per mould: 1
 Plastic per product: 28 g
 Workflow: ●●●●●○

Size product: L: 90 mm W: 103 mm H: 4 mm
 Size mould: H: 115 mm L: 120 mm W: 50 mm
 Weight mould: 1.7 kg

Price: 300 €*

Interlocking Brick Mould

Stacks perfectly – be creative and build all kinds of different objects.

Plastic per mould: 115 g
 Products per mould: 1
 Plastic per product: 113 g
 Workflow: ●●●●○

Size product: L: 69 mm W: 137 mm H: 54 mm
 Size mould: H: 85 mm L: 168.4 mm W: 100 mm
 Weight mould: 3 kg

Price: 550 €*

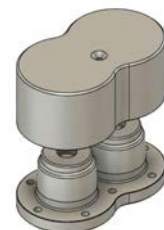

Ocean Jewelry Mould

Lovely to show your connection to the ocean. The set includes an anchor, a shell, a turtle and a shipping wheel – all products have a 2.5 mm jewelry ring.

Plastic per mould:	20 g
Products per mould:	8
Plastic per product:	Anchor: 1 g, Shell: 3.8 g Turtle: 1.7 g, Weel: 1 g
Workflow:	●●●●●●●●
Size product:	Anchor : 34.5 x 21 x 5 mm Shell: 33 x 35.5 x 8.3 mm Turtle: 29 x 36 x 6.5 mm Weel: 38 x 30 x 3 mm
Size mould:	H: 95 mm L: 200 mm W: 50 mm
Weight mould:	2.4 kg
Price:	750 €*



Playing Pieces Mould

Perfect for many board games.

Plastic per mould:	12 g
Products per mould:	8
Plastic per product:	1.4 g
Workflow:	●●●●●●●●
Size product:	D: 12 mm H: 24 mm
Size mould:	H: 95 mm L: 102 mm W: 40 mm
Weight mould:	1 kg
Price:	325 €*

Round Coaster Mould

Perfect to use as a coaster. Ideal for engraving.

Plastic per mould:	24 g
Products per mould:	1
Plastic per product:	23 g
Workflow:	●●●●●●●●
Size product:	D: 90 mm H: 4 mm
Size mould:	H: 115 mm L: 120 mm W: 50 mm
Weight mould:	1.7 kg
Price:	200 €*

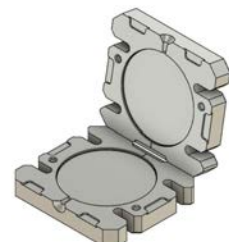

Rulers Mould 15 cm

Perfect as a giveaway, also with personalized engraving.
Due to tolerance deviations, the ruler is not intended for school purposes.
The scale of the cavity is intended for PP and is plus 1.7133 %

Plastic per mould: 29 g
Products per mould: 2
Plastic per product: 13 g
Workflow: ●●●●●●●●●●

Size product: L: 162.741mm W: 25 mm H: 4 mm
Size mould: H: 95 mm L: 200 mm W: 40 mm
Weight mould: 1.85 kg

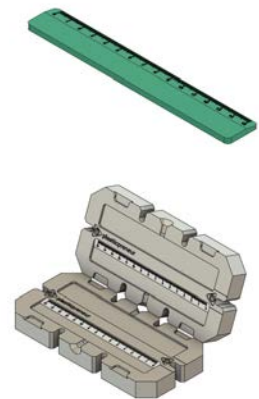

Price: 450 €*



Spinning Top Mould

Perfect as a giveaway for workshops – kids love it!

Plastic per mould: 20 g
Products per mould: 2
Plastic per product: 9 g
Workflow: ●●●●●●●●●●

Size product: D: 40 mm H: 40 mm
Size mould: H: 60 mm L: 110 mm W: 50 mm
Weight mould: 0.74 kg

Price: 400 €*

Shovel Mould

Perfect to play in the sand with or using in the garden.

Plastic per mould: 43 g
Products per mould: 1
Plastic per product: 41 g
Workflow: ●●●●●●●●●●

Size product: L total: 183 mm
L shovel: 100 mm W shovel: 77 mm
H shovel: 38.5 mm L handle: 83 mm
W handle: 15.8 mm H handle: 13.7 mm
Size mould: H: 211 mm L: 107 mm W: 60 mm
Weight mould: 3.4 kg

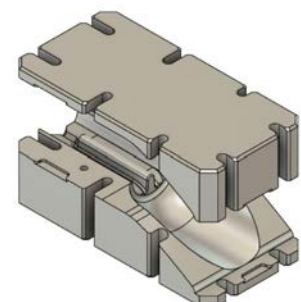

Price: 875 €*

Square Bowl Mould

Perfect as a decorative non food bowl for accessories or as screw box.

Plastic per mould: 46 g
 Products per mould: 1
 Plastic per product: 45 g
 Workflow: ●●●●●

Size product: L1: 78 mm L2: 62 mm H: 50 mm
 Size mould: H: 80 mm L: 120 mm W: 120 mm
 Weight mould: 2.9 kg

Price: 550 €*



3D Aluminum Standard Mould Order	Custom Mould Order
To place an order for our standard 3D aluminum moulds, please contact us at the following email address: products@plasticpreneur.com	If you desire the creation of custom moulds tailored more closely to your needs, please send us an email to: moulds@plasticpreneur.com